

 Crafted in Switzerland



PC-24
THE CRYSTAL CLASS

THE SUPER VERSATILE JET



 **PILATUS** 

YOUR OWN PILATUS JET

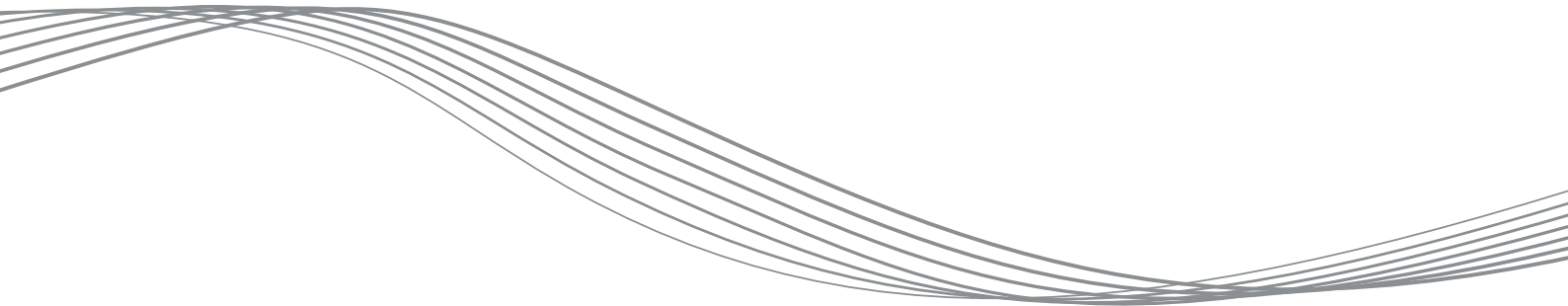



PC-24
THE CRYSTAL CLASS

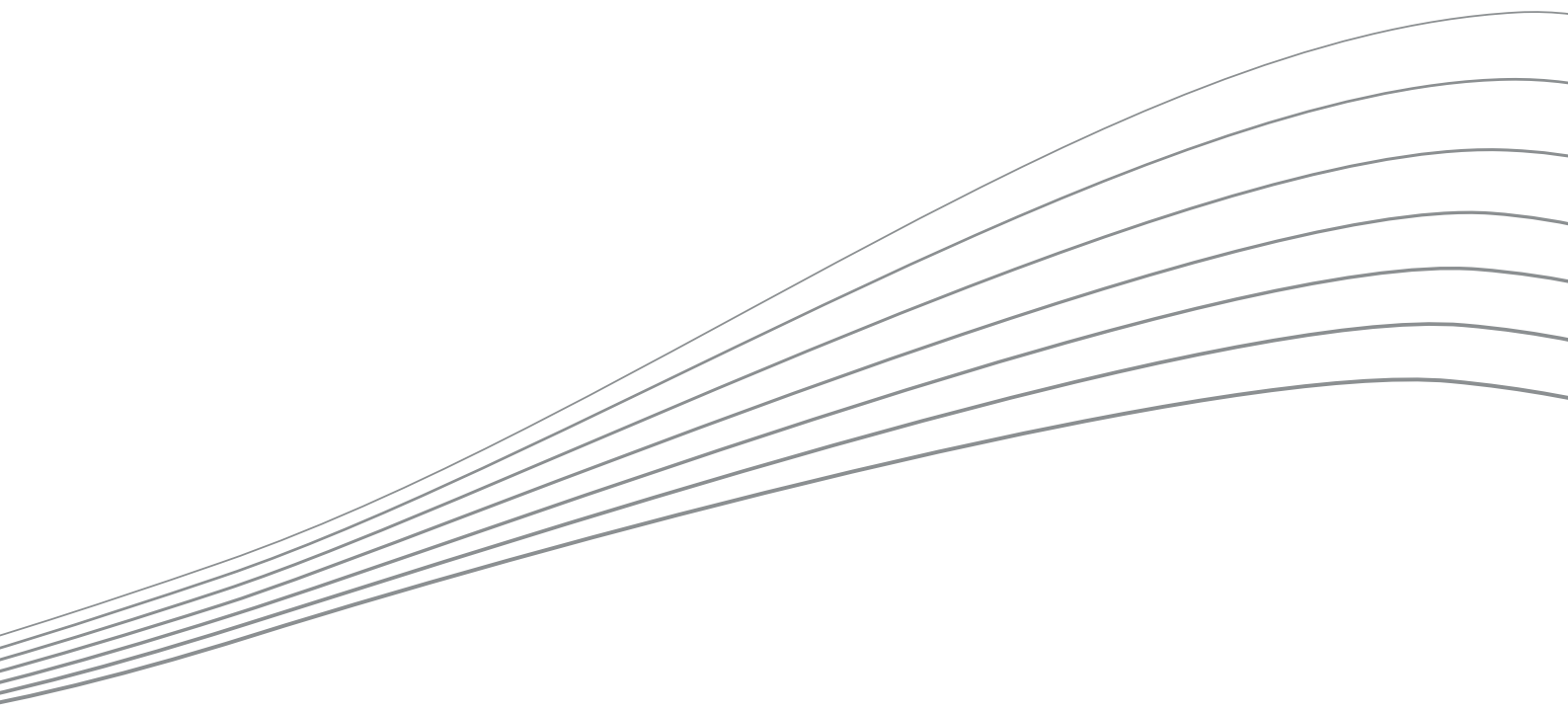



Jackson, Kentucky, USA | 37°33'49"N | 83°11'31"W

A CLASS OF ITS OWN

6

WELCOME ON BOARD

14

AVIONICS AND POWERPLANT

24

CUSTOMER SUPPORT

32

SWISS CRAFTSMANSHIP

34

WHY OWN A PC-24?

38

FACTS AND FIGURES

40

CONTACT US

50





Planggenstock Mountain, Canton Uri, Switzerland | 46°37'50"N | 8°28'24"E

A CLASS OF ITS OWN

THE CRYSTAL CLASS

People become enchanted when they experience something as unique and out of reach as a Swiss mountain crystal.

Its elegance expresses something words cannot describe. The diverse and unmistakable shape of the crystal has always fascinated. Perhaps it's the hardness that conveys a sense of durability. Or because it is created deep within the mountain, emerging only after a long and arduous journey. Or maybe it's because the details of its origin and formation will forever remain a secret. Either way, one thing is for sure: its beauty sparks the imagination.

For some, Swiss mountain crystals are a symbol of strength and power. For others, their countless facets make them a symbol of variety and uniqueness.

Crystal seekers from the Swiss Alps – called “Strahler” – discover the crystals only after tremendous effort and endurance. Working high in the mountains, they must withstand every type of weather and bear any temperature before they can hold a crystal in their hands.

Our latest aircraft is just as versatile, powerful, and extraordinary as a Swiss mountain crystal: the Pilatus PC-24.



A high-angle, top-down view of a blue Pilatus PC-24 aircraft flying over a rugged, mountainous landscape. The aircraft is positioned on the right side of the frame, with its wings and tail extending towards the left. The terrain below is a mix of brown, rocky ground and a large, white glacier. The lighting is bright, casting shadows on the ground.

A CLASS OF ITS OWN

THE WORLD'S FIRST AND ONLY SVJ

Every crystal found in the mountains of Switzerland is entirely unique. Just as unique is the PC-24, the only aircraft combining the cabin size of a midsize jet with the versatility of a turboprop and operating cost of a light jet.

It's a plane that simply doesn't fit into any of the existing business jet categories. That's why we had to create a new one: the Super Versatile Jet category. Pilatus is proud to present the world's first and only Super Versatile Jet: the Pilatus PC-24.

Fiesch Glacier, Canton Valais, Switzerland | 46°29'52"N | 8°8'48"E



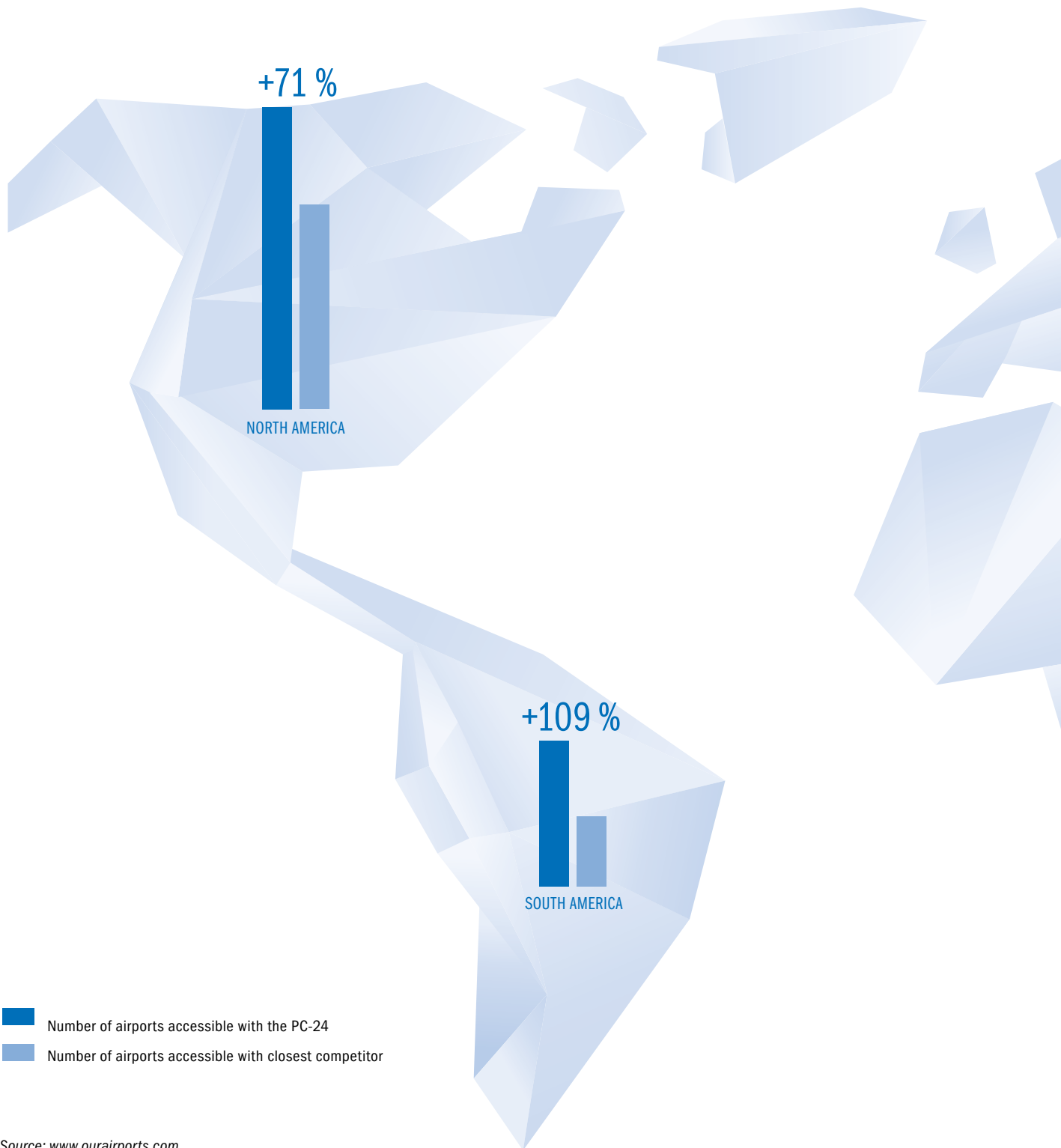

- Number of airports accessible with the PC-24
- Number of airports accessible with closest competitor

Source: www.ourairports.com

A total of 35,000 airports worldwide for which sufficient valid data was available were included in the study.

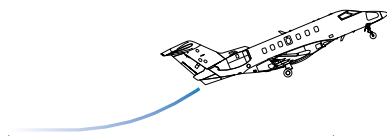

Take-off distance: 2,930 ft (893 m)

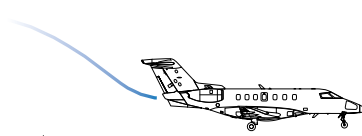

Landing distance: 2,375 ft (724 m)

+69 %



EUROPE

+27 %



ASIA

+203 %



AFRICA

+177 %



OCEANIA

A CLASS OF ITS OWN

GO WHERE NO BUSINESS JET HAS GONE BEFORE

Like crystals, runways around the world have innumerable facets. There are around 10,650 airports in the world that you can access with an aircraft able to operate on runways with a length of 3,130 feet (954 m). There are an additional 880 airports that become available when your aircraft needs only 2,930 feet (893 m). Of course, in both cases these runways will have to be paved.

Now let's look at the number of runways around the world that feature unpaved surfaces – like grass or gravel.

The number is almost 20,000! So with the PC-24, you will have access to almost 100 percent more airports around the world.

That means you can fly closer to your final destination than with any other business jet. You'll be able to use smaller airports and avoid massive administrative procedures, and reduce ground transfer time to an absolute minimum.



A PC-24 aircraft is shown in the process of taking off from a dirt runway. The aircraft is positioned on the right side of the frame, with its wings and tail visible. A large, billowing cloud of dust is kicked up from the runway surface, partially obscuring the aircraft and filling the background. The sky is a clear, pale blue. The overall scene conveys a sense of ruggedness and the aircraft's capability to operate in less-than-ideal conditions.

A CLASS OF ITS OWN

AT HOME ON RUNWAYS EVEN WHERE THERE ISN'T ONE

"No one will ever operate a multi-million-dollar aircraft on dirt strips." Oh yes, we've heard that one over the years. In the meantime, a growing fleet of over 1,800 PC-12s has proven that statement false. This fleet has accumulated over eight million flight hours, including countless take-offs and landings in locations where "dirt strip" is a generous description of the available ground infrastructure.

We listened carefully to the feedback of PC-12 owners operating under challenging conditions, and everything we learned from their previous experiences is now woven into the DNA of the PC-24. Its outstanding short-field performance opens up an incredible level of mobility. PC-12 owners know why rough and short-field capability is such an advantage. And PC-24 owners will know it too.



The image shows the interior of a private jet cabin, specifically a lavatory area. A white sink with a chrome faucet is mounted on a dark wood-paneled wall. Above the sink is a mirror. The cabin features dark wood paneling and a white ceiling. A passenger seat is visible on the right side of the frame.

WELCOME ON BOARD

GREAT MINDS NEED PLENTY OF HEADROOM

The PC-24's cabin volume tops business jets costing almost twice as much. But while offering space is one thing, making intelligent use of it is quite another.

The interior of the PC-24 has been designed from the outset for quick and easy reconfiguration – an option not found in many other business jets. Each passenger seat features quick-change capability enabling its addition or removal. The aft partition is movable so

you can easily enlarge the passenger cabin or increase the baggage compartment volume for each and every flight. The PC-24 features a fully enclosed, externally serviceable private lavatory that is highly discreet and seamlessly integrated into the forward area of the cabin. Being a Super Versatile Jet, the PC-24 finds popularity in a number of other roles – like cargo, medevac, commuter, or governmental special-mission applications, just to name a few.





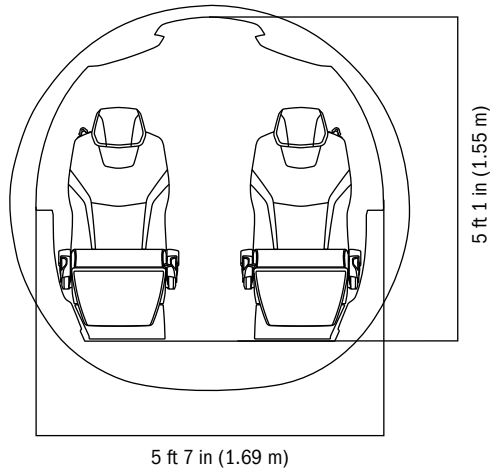

WELCOME ON BOARD

LIKE A PENTHOUSE ON THE 5,000TH FLOOR

The PC-24 saves you time by bringing you closer to where you want to be. And you won't have to make any compromises on your way.

Long before settling into your seat, you'll find yourself impressed by the generous space and striking elegance of the PC-24's cabin. Ergonomics and comfort are both at premium levels.

Only the finest-quality materials have been used to create an interior that fits in perfectly with the latest

standards of comfort and functionality. Every component is chosen to enhance the passenger experience: soft leathers and rare hardwood cabinetry full of exquisite details create a bespoke interior that reflects the meticulous purpose of the aircraft.

13 extra large cabin windows flood the interior of the PC-24 with bright, natural light. The generously sized cabin, with its continuous flat floor, allows for an exceptional amount of headroom for both passengers and crew. It's not first class travelling – it's Crystal Class.





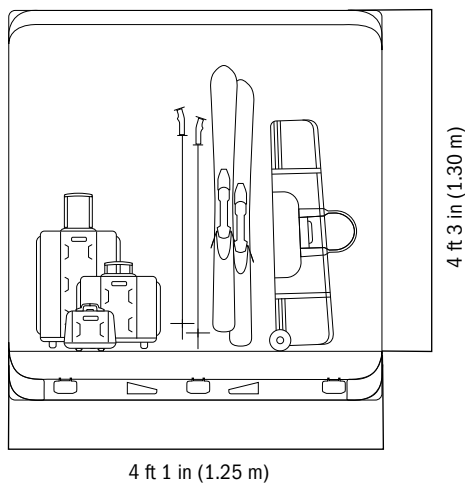

WELCOME ON BOARD

A JET SO PRIVATE, EVEN THE BAGGAGE HAS ITS OWN DOOR

Every iconic product incorporates at least one hallmark feature that dramatically differentiates it from the competition. Introducing the world's first business jet with a standard pallet-sized cargo door. Its dimensions are simply outstanding, and its advantages are equally impressive. It's how a business jet becomes a Super Versatile Jet.

Whether you're carrying spare parts or baggage for all your passengers, loading even the bulkiest of items has never been easier.

Some of our PC-12 customers have been known to take their motorbike with them. Now they can do that at jet speed.

The image shows the interior of a private jet cabin. The seats are upholstered in cream-colored leather with black piping. A dark wood-grain table is in the foreground with a glass bottle on it. The cabin has large windows and overhead storage bins. The lighting is bright and even.

WELCOME ON BOARD

ENOUGH SPACE FOR YOUR BAGGAGE AND YOUR FRIENDS'

The biggest door is useless when there is no space behind it. That's why we've designed the PC-24 so that there is ample space behind the cargo door. The volume of the baggage compartment surpasses what is available on aircraft costing millions more to buy and operate. Or if you'd prefer to travel light and would like more room

for you and your fellow passengers, simply move the aft partition back. You'll enjoy even more space to stretch out, and still have plenty of baggage space. And on top of all that, your valuable belongings will always be carried in a heated and fully pressurised cabin section, which is accessible at any time during the flight.





Avignon-Provence Airport, Provence-Alpes-Côte d'Azur, France | 43°54'26"N | 4°54'7"E



IMPRESSIVE ON PAPER – REMARKABLE IN THE AIR

- Operate with a balanced field length as short as 2,930 feet (893 m)
- Take off and land on paved and unpaved runways
- Stretch out in the spacious cabin with a continuous flat floor
- Create exactly the right amount of space with multiple quick-change interior configurations
- Load quickly and easily with a standard pallet-sized cargo door
- Keep everything close by in the in-cabin baggage compartment
- Enjoy superior versatility

How many more reasons do you need?





AVIONICS AND POWERPLANT DESIGNED FOR 45,000 FEET AND TWO HANDS

All Pilatus aircraft are certified for single-pilot operation. And the PC-24 is no exception to this rule.

The cockpit layout is efficient and intuitive. From the comfort of the seat, the pilot finds an environment that has been designed specifically to reduce workload and

improve safety while providing full situational awareness under all circumstances. Simply put, the PC-24 is the perfect combination of single-pilot operational know-how, and state-of-the-art avionics technology.

And of course the PC-24 can also be flown by two pilots.



Panel with various switches and indicators, including 'R ENG ISOL' and 'FIRE XTING'.

RADIO-CALL RB-VSA panel with multiple frequency buttons and a call button.

Multifunction Display (MFD) showing a terrain map and various flight data.

BARO (Barometric Pressure) control panel with various settings and indicators.

Central Synthetic Vision Display (SVD) showing a 3D terrain view, runway, and flight instruments.

Engine Instrumentation Display (EID) showing engine parameters like RPM, EGT, and oil pressure.

Left side instrument panel with fuel gauges, environmental readouts, and other system indicators.

OXYGEN control panel with 'PUSH TO ACTIVATE' button and oxygen level indicators.

Dual control yokes with various buttons and switches for flight control.

Panel with various system controls, including cabin altitude and other safety features.

Panel with various system controls, including cabin altitude and other safety features.

Panel with various system controls, including cabin altitude and other safety features.

AVIONICS AND POWERPLANT

FIRST FASTEN YOUR EXCITEMENT THEN YOUR SEATBELT

The PC-24's Advanced Cockpit Environment (ACE) sets the standard for high-tech simplicity.

Pilatus ACE is so capable and offers such a wealth of functionality that in its most basic configuration it boasts the most intuitive and user-friendly cockpit concepts ever seen in business aviation.

Four 12-inch screens ensure that all relevant information is displayed in the right place and with no delay.

The Inertial Reference System guarantees excellent reliability and accuracy of altitude and navigation data. The Pilatus ACE also features a Synthetic Vision System, Autothrottle, Graphical Flight Planning, Traffic Collision Avoidance System, and Localiser Performance with Vertical Guidance capability.





WARNING
HOT SURFACE

AVIONICS AND POWERPLANT

CONSUMPTION, EMISSIONS, NOISE: ALL MINIMISED

At Pilatus, our legacy of innovative and efficient technology is driven by the world around us. To power the PC-24, we chose the Williams International FJ44-4A, a world-renowned power unit. It delivers ample power to support the PC-24's excellent field performance and enables a direct climb to the PC-24's operational ceiling. But we wouldn't be Pilatus if we simply settled there – we wanted to go further.

Here's another world premiere: the PC-24's unique Quiet Power Mode provides quiet, economical energy to power electrical systems – including heating and air-conditioning – independent of any source of ground power.

These innovations offer more operational flexibility and higher fuel efficiency. Or to put it simply: super versatility.



Maximum cruise speed: 440 knots (815 km/h)
Maximum range: 6 passengers 1,800 nm (3,334 km)
4 passengers 2,000 nm (3,704 km)



BUILT FOR THE YEEEEEEHA!

Just imagine: You've worked so hard for so long, and now it's time for a well-deserved rest. Gather your family and friends together to enjoy a weekend. Carry all their belongings and just take off.

With the PC-24's speed and range, you'll reach all your destinations in a breeze. Its incredibly slow approach speed and sophisticated braking/lift dump system

reduce the landing distance to an absolute minimum, and keep every landing safe. The PC-24's superior runway performance enables you to operate from thousands of airstrips that the competition can only fly over.

That's why we call the PC-24 a Super Versatile Jet: more runways, more space, more possibilities.





Otago, New Zealand | 45°38'50"S | 169°30'3"E



PC-24

THE CRYSTAL CLASS

SUPPORT

CUSTOMER SUPPORT

AT PILATUS, WE SUCCEED WHEN OUR CUSTOMERS SUCCEED

We've gained a deep understanding of the needs and expectations of our customers. How do we know this? In survey after survey, PC-12 owners and operators rank Pilatus customer service the highest in the industry.

As an owner of an aircraft made by Pilatus, you will receive personal attention through our global service network. Training, spare parts and customer programmes

are just a mouse click or phone call away. In addition, each Pilatus aircraft comes with one of the strongest new aircraft warranties in the industry.

Pilatus makes every effort to ensure maximum uptime for your aircraft. In short, we worry about the aircraft so you don't have to. As you can see, our customer service is more than first class – it's Crystal Class.







SWISS CRAFTSMANSHIP

OVER-ENGINEERED – AND PROUD OF IT

Switzerland is known for several things – watches, mountains, cheese, chocolate and, of course, mountain crystals.

To the general public, aircraft aren't on that list. But aviation enthusiasts know that Switzerland is home to a world-famous aircraft innovator.

A team of over 300 highly skilled engineers was tasked with the development of the PC-24, the next great

aircraft from Pilatus. True to our heritage, the PC-24 is brilliant not only in performance and beauty – it's also brilliantly practical. And that's why we've labelled it a Super Versatile Jet.

The numerous components of each aircraft are brought together by experienced technicians who take pride in their work. Every PC-24 that leaves our production line is uniquely tailored to meet the owner's individual needs and requirements.





St. Gotthard Pass, Canton Ticino, Switzerland | 46°33'33"N | 8°33'42"E

SWISS CRAFTSMANSHIP

THE PILATUS STORY

We're not as old as a Swiss mountain crystal, but our history is just as rich. Since 1939, Pilatus has built a reputation for constructing aircraft that excel in demanding conditions without compromising speed, safety or comfort.

The Pilatus Porter PC-6 has been heralded as one of the most extraordinary bush planes ever built and was also known as the world's leading STOL. First flown in 1959, it was one of the longest produced aircraft of all time.

Our military training aircraft, the PC-7 MkII, the PC-9 M, and the PC-21 make up a product family with which thousands of air force pilots around the world have earned their wings. The PC-12 is the benchmark for outstanding versatility, performance, reliability and operational flexibility. As such, it is one of the most popular turbine-powered business aircraft on the market today.

From our proud heritage comes knowledge: the PC-24 embodies all of this experience and represents the pinnacle of over 80 years of precision aircraft manufacturing.





Idaho, USA | 44°8'30"N | 115°0'36"W

WHY OWN A PC-24?

TEN REASONS

1. MORE AIRPORTS

No other business jet can operate from paved and even unpaved surfaces as short as 2,930 feet (893 metres) – this gives you access to almost 20,000 additional airports worldwide.

2. CABIN SPACE

No other business jet offers this much cabin space with an entirely flat floor at this price level in its category. The interior configuration can quickly be adapted to your needs.

3. ADVANCED COCKPIT

No other business jet features a more capable standard cockpit environment at this price level.

4. CARGO DOOR

No other business jet includes as standard a generous cargo door that makes loading quick and easy.

5. BAGGAGE COMPARTMENT

No other business jet in this class features a comparable all-internal, pressurised and in-flight-accessible baggage compartment.

6. IMPROVED SAFETY

No other business jet at this price level offers such a combination of high-tech and simplicity that helps improve situational awareness and safety.

7. QUIET POWER MODE

No other business jet offers aircraft cooling or heating on the ground under its own power with the revolutionary Quiet Power Mode.

8. OPERATIONAL FLEXIBILITY

No other business jet is a Super Versatile Jet giving you the most operational flexibility possible.

9. CRYSTAL CLASS SUPPORT

No other business jet offers Crystal Class Support – business aviation’s most comprehensive warranty and service package, provided by a global network ranked number 1 in the industry for 19 consecutive years.

10. SWISS QUALITY

No other business jet is made in Switzerland by a manufacturer with an unmatched reputation for precision such as ours – we’re proud to be called over-engineered.



FACTS AND FIGURES

DIMENSIONS AND WEIGHTS

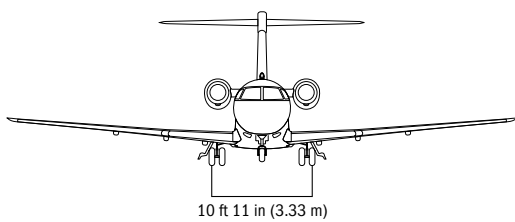
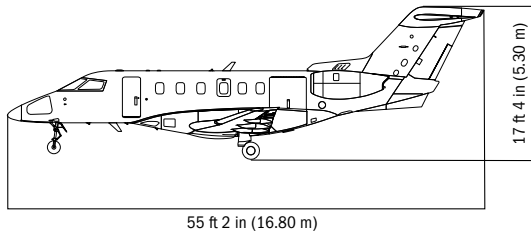
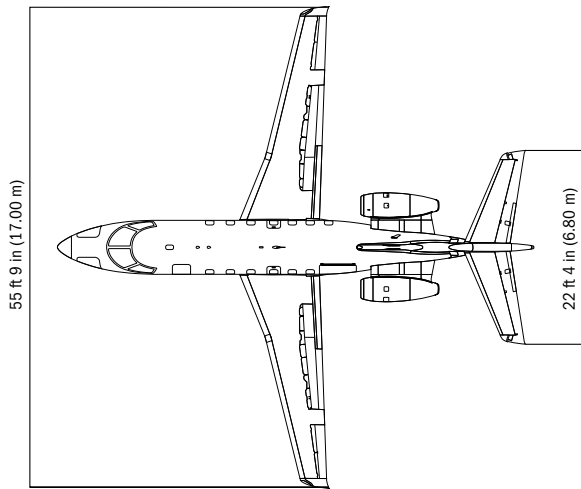

DIMENSIONS (EXTERIOR)

Wing span	55 ft 9 in	17.00 m
Length	55 ft 2 in	16.80 m
Height	17 ft 4 in	5.30 m
Horizontal tail span	22 ft 4 in	6.80 m

DIMENSIONS (INTERIOR)

Cabin length (<i>cockpit/cabin partition to aft pressure bulkhead</i>)	23 ft 0 in	7.01 m
Cabin width	5 ft 7 in	1.69 m
Cabin floor width	3 ft 10 in	1.16 m
Cabin height (<i>continuous flat floor</i>)	5 ft 1 in	1.55 m
Cabin volume (<i>cockpit/cabin partition to aft pressure bulkhead</i>)	501 ft ³	14.20 m ³
Baggage compartment volume (<i>aft partition in forward position</i>)	90 ft ³	2.50 m ³
Baggage compartment volume (<i>aft partition in aft position</i>)	51 ft ³	1.40 m ³
Passenger door height	4 ft 5 in	1.34 m
Passenger door width	2 ft 0 in	0.60 m
Cargo door height	4 ft 3 in	1.30 m
Cargo door usable width	4 ft 1 in	1.25 m

WEIGHTS

Maximum ramp weight	18,400 lb	8,345 kg
Maximum take-off weight	18,300 lb	8,300 kg
Maximum landing weight	16,900 lb	7,665 kg
Maximum zero fuel weight	14,220 lb	6,450 kg
Usable fuel (888.5 U.S. gal)	5,964 lb	2,705 kg
Maximum payload	2,500 lb	1,134 kg
Maximum payload with full fuel	715 lb	324 kg
Basic operating weight (executive configuration 6 seat, incl. one pilot)	11,720 lb	5,316 kg

POWERPLANT

Manufacturer	Williams International	
Model	FJ44-4A	
Normal take-off thrust (per engine)	3,420 lbf	1,551 kgf
Automatic thrust reserve allowing thrust increase to	3,600 lbf	1,633 kgf
Dual channel Full Authority Digital Engine Control (FADEC)		
Aircraft cooling or heating on the ground under own power (Quiet Power Mode)		
Time between overhaul	5,000 h	
Hot section inspection	2,500 h	
Inspection	300 h	



FACTS AND FIGURES

PERFORMANCE

TAKE-OFF DISTANCE

Balanced field length 2,930 ft 893 m
(MTOW, ISA, sea level, dry paved runway)

Balanced field length 4,980 ft 1,518 m
(MTOW, ISA +20 °C, 5,000 ft, dry paved runway)

RATE OF CLIMB

(200 KCAS/M 0.6)

MTOW, sea level 4,070 ft/min 20.70 m/s

FL 300 1,967 ft/min 10.00 m/s

Time to climb sea level to FL 450 26 min
(direct climb)

CRUISE

Maximum cruise speed *(FL 280)* 440 KTAS 815 km/h

PAYLOAD/RANGE

(NBAA IFR reserves of 100 nm (185 km) LRC + 30 min VFR holding, single-pilot operations)

Max payload *(2,500 lb/1,134kg)* 1,182 nm 2,189 km

6 passengers *(1,200 lb/544 kg)* 1,800 nm 3,334 km

4 passengers *(800 lb/363 kg)* 2,000 nm 3,704 km

Ferry range 2,106 nm 3,900 km

ALTITUDE

Maximum certified altitude 45,000 ft 13,716 m

Maximum altitude single
engine service ceiling 30,000 ft 9,144 m

LANDING DISTANCE

Over 50 ft (15 m) obstacle 2,375 ft 724 m
(MLW, ISA, sea level, dry paved runway)

STALL SPEED

Landing configuration 82 KIAS 151 km/h
(MLW, ISA, sea level)

WING AREA AND LOADING

Wing area 332.71 ft² 30.91 m²

Wing loading 55 lb/ft² 269 kg/m²

FACTS AND FIGURES

AVIONICS AND MISCELLANEOUS

PILATUS ACE AVIONICS SYSTEM

ACE stands for “Advanced Cockpit Environment” system specifically developed for the Pilatus PC-24.

Key features:

- Four 12-inch LCD displays
- Inertial reference system and attitude heading reference system
- SmartView synthetic vision system
- Traffic alert and collision avoidance system
- Graphical flight planning
- Autothrottle
- Lateral precision vertical
- Fully integrated automatic flight control system
- Dual flight management system
- Dual Mode S transponders with automatic dependent surveillance – broadcast OUT

KINDS OF OPERATIONS

- Visual flight rules
- Instrument flight rules day and night
- Private (*FAR Part 91, EASA Part-NCC*) and commercial (*FAR Part 135, EASA Part-CAT*) operations
- Flight into known icing conditions
- Single- and dual-pilot operations
- Operations from paved and unpaved surfaces

MISCELLANEOUS

Airframe maintenance schedule	600 h/annual
Design service life	30,000 h/30,000 landings
Certification	EASA CS 23; FAA FAR 23, Commuter Category

- Dual wheel main landing gear; low pressure tyres (72 psi)
- Single-point pressure refuelling port



FACTS AND FIGURES

RANGE

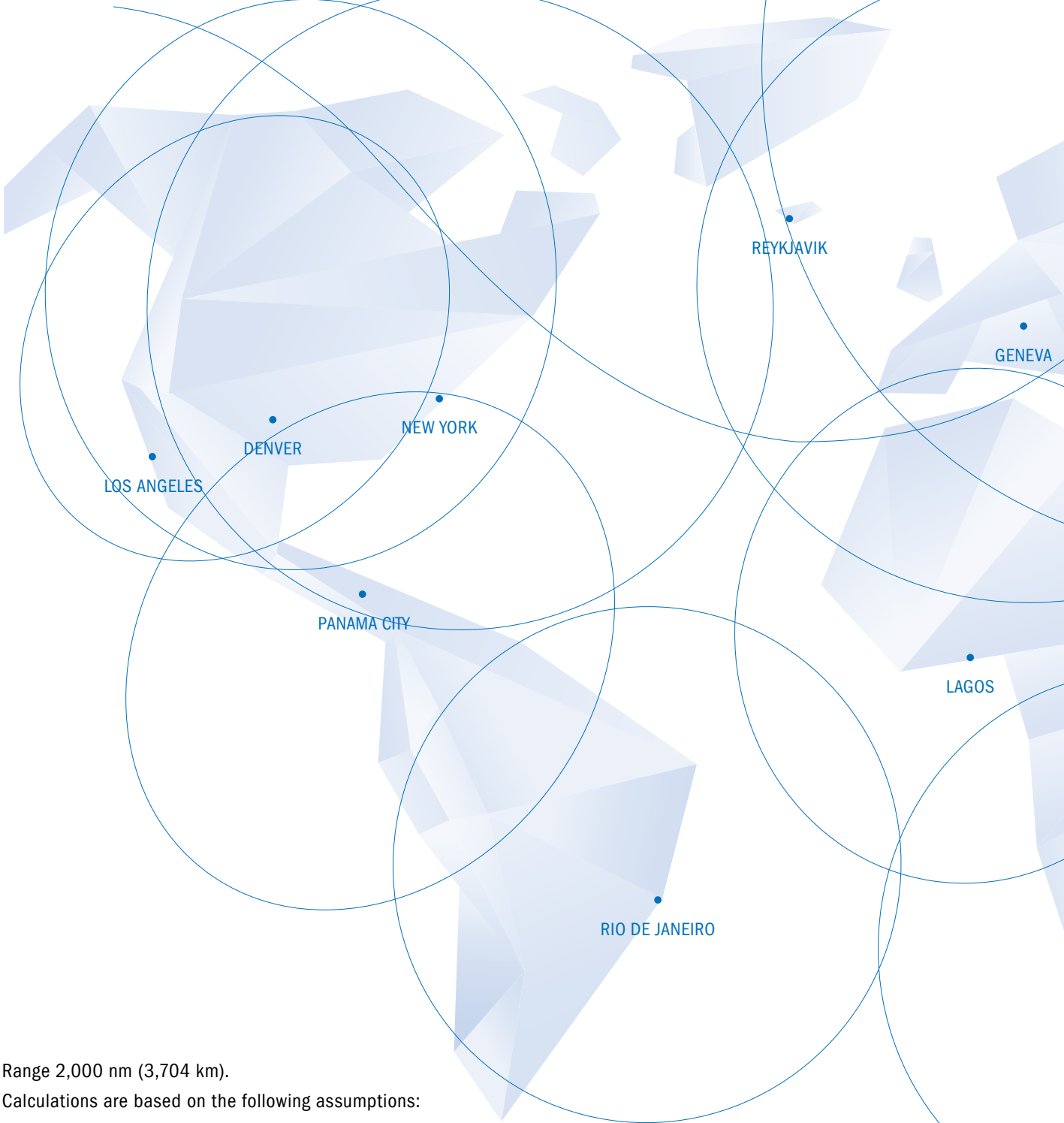

Range 2,000 nm (3,704 km).
Calculations are based on the following assumptions:
4 passengers, NBAA IFR reserves of 100 nm LRC +
30 min VFR holding, single-pilot operation.



FACTS AND FIGURES

INTERIOR CONFIGURATIONS



1



2



3



4

1 | 6 SEAT EXECUTIVE

Make the most out of the PC-24 cabin with ample space for passengers, baggage and equipment.

2 | 8 SEAT DOUBLE CLUB EXECUTIVE

Fill every seat of the plane and still take advantage of an impressive baggage compartment and comfortable seating.

3 | 6 + 2 SEAT EXECUTIVE

Whenever the need arises, simply add or remove up to two seats, allowing flexible accommodations for six to eight passengers.

4 | 6 + 2 SEAT COMMUTER

Whenever the need arises, simply add or remove up to two seats, allowing flexible accommodations for six to eight passengers.



5

5 | COMMUTER

A true workhorse, it will transport passengers and their gear to the most remote locations – quickly and safely.

6 | COMBI

Whether it's a critical spare part or simply your motorcycles – travel in style and leave nothing behind.



6

7 | CARGO

So many options: ambulance operations, special missions, cargo – let us know how you plan to use the PC-24's cabin.



7

FACTS AND FIGURES

NUMBERS ARE ESSENTIAL, THEIR MEANING EVEN MORE

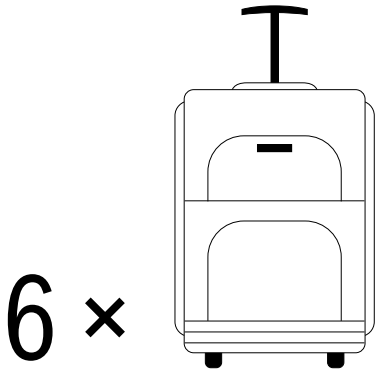

BIG SUITCASE

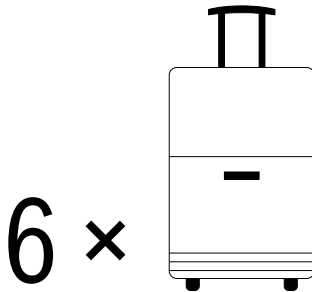

MEDIUM SUITCASE

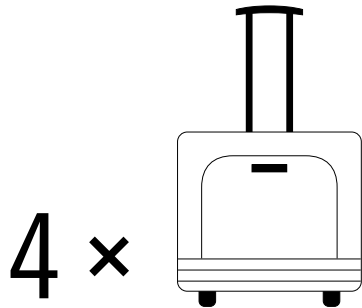

CABIN BAGGAGE



PACK YOUR BAGS AND LET'S FLY.

Number of luggage pieces (illustrative) that fit into the baggage compartment.

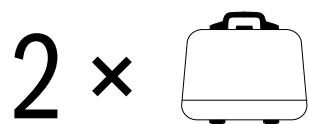

BEAUTY CASE

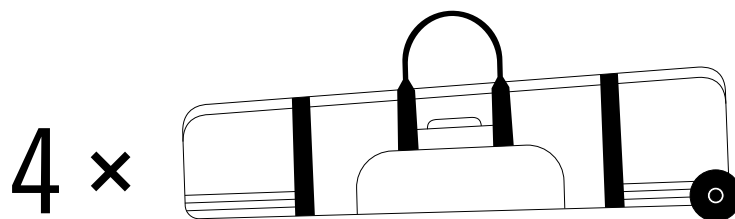

GOLF BAG

CONTACT US

FLY CRYSTAL CLASS

PLEASE CONTACT US FOR
MORE INFORMATION.

International Phone +41 41 619 67 00

US Phone +1 303 465 9099

Australian Phone +61 8 8238 1600

pc-24sales@pilatus-aircraft.com

www.pilatus-aircraft.com/pc-24

The Pilatus logo consists of the word "PILATUS" in a bold, sans-serif font, with stylized horizontal lines above and below the letters 'P' and 'S'.

AUTHORISED CENTRE

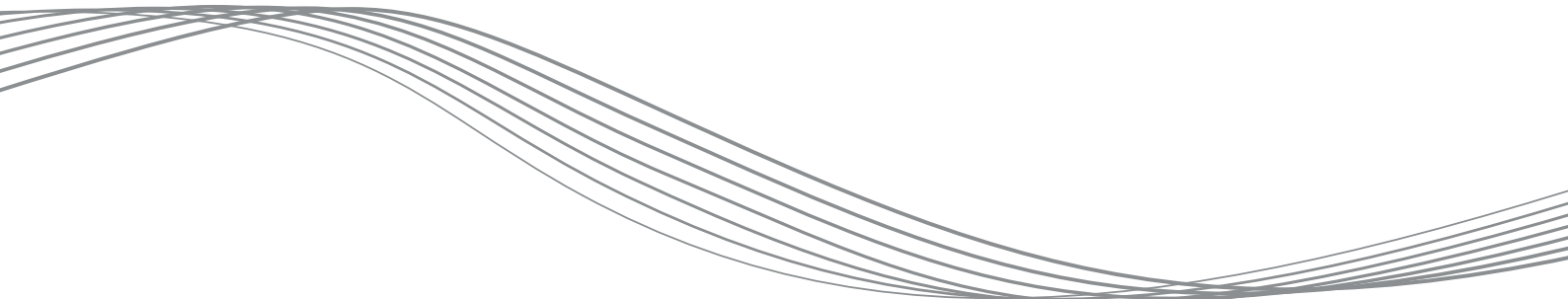

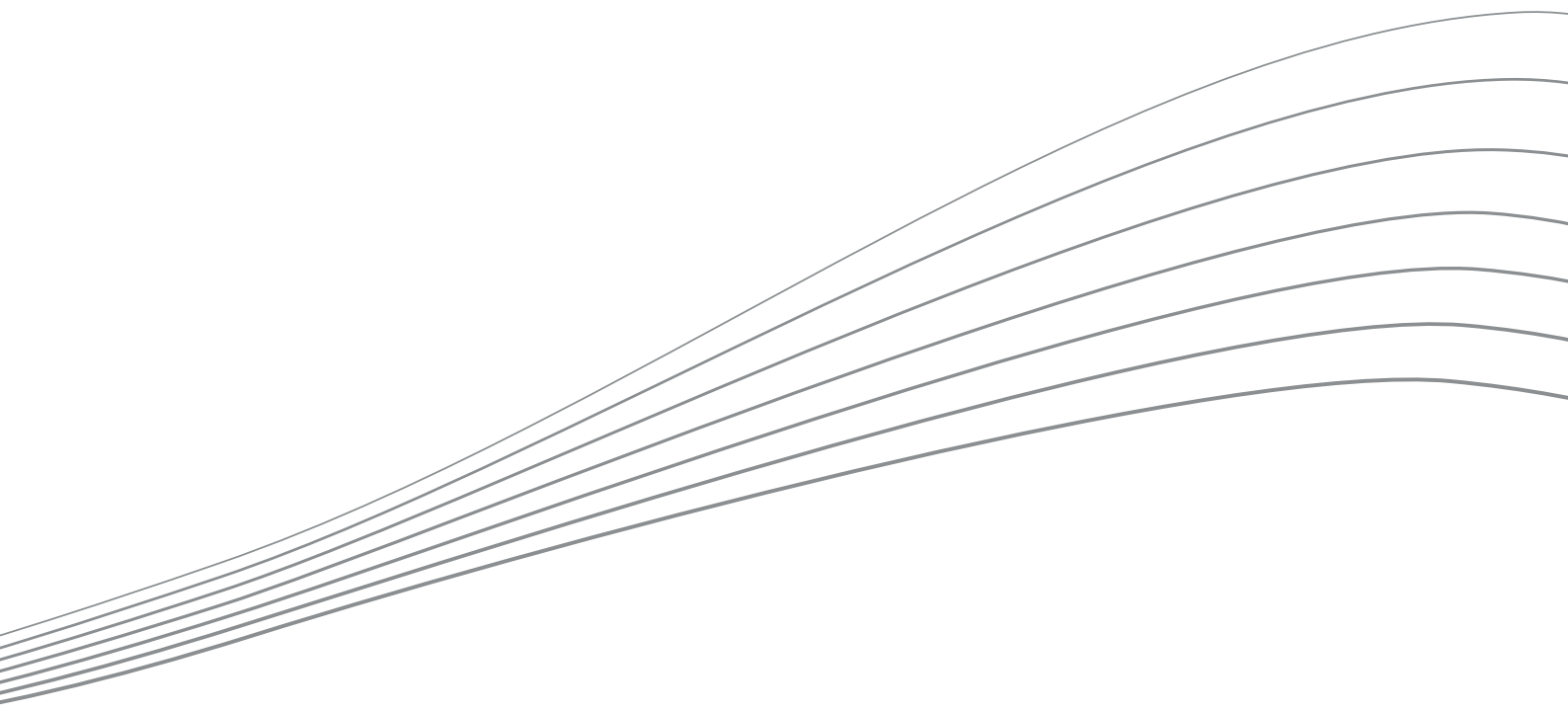

Founded in 1939, Pilatus Aircraft Ltd is the only Swiss company to develop, produce and sell aircraft to customers around the world: from the legendary Pilatus Porter PC-6 to the best-selling single-engine turboprop in its class, the PC-12, and the PC-21, the training system of the future. The latest aircraft is the PC-24 – the world's first ever business jet for use on short unprepared runways. Domiciled in Stans, the company is certified to ISO 14001 in recognition of its efforts for the environment. The Pilatus Group includes two independent subsidiaries in Broomfield (Colorado, USA) and Adelaide (Australia). With over 2,000 employees at its headquarters, Pilatus is one of the largest employers in Central Switzerland. Pilatus provides training for about 130 apprentices in 13 different professions – job training for young people has always been a very high priority at Pilatus.

Pilatus Aircraft Ltd

P.O. Box 992
6371 Stans, Switzerland
Phone +41 41 619 61 11
info.stans@pilatus-aircraft.com

Pilatus Business Aircraft Ltd

Rocky Mountain Metropolitan Airport
12300 Pilatus Way
Broomfield, CO 80021, USA
Phone +1 303 465 9099
info.broomfield@pilatus-aircraft.com

Pilatus Australia Pty Ltd

3 Tower Road
Adelaide Airport SA 5950, Australia
Phone +61 8 8238 1600
info.adelaide@pilatus-aircraft.com

